

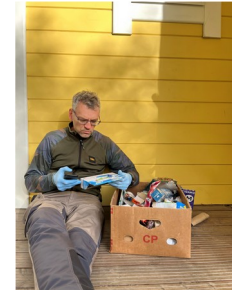

Euroopa Maaelu Arengu
Põllumajandusfond:
Euroopa investeeringud
maapiirkondadesse

Pakendil on sõnum

Pakendivaldkonna infopäev
Taaskasutusmürgiste kasutamine pakenditel
Margus Vetsa
TLÜ keskkonnakorraldus



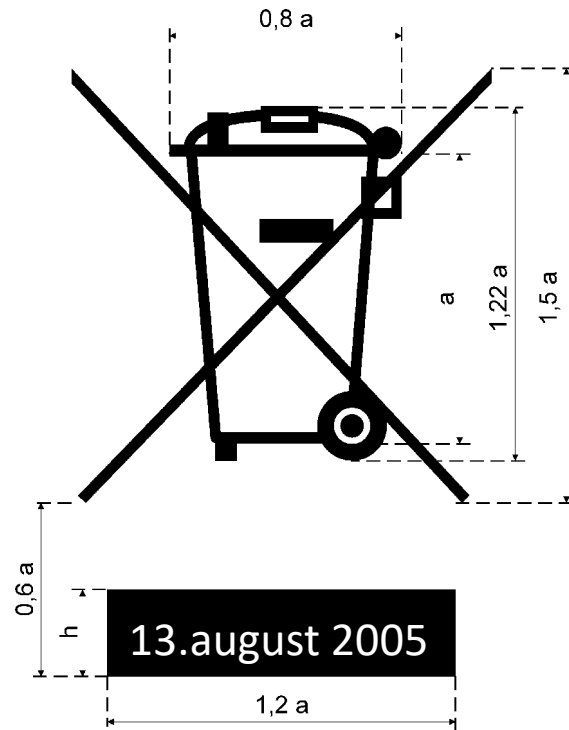

Kohustuslikud

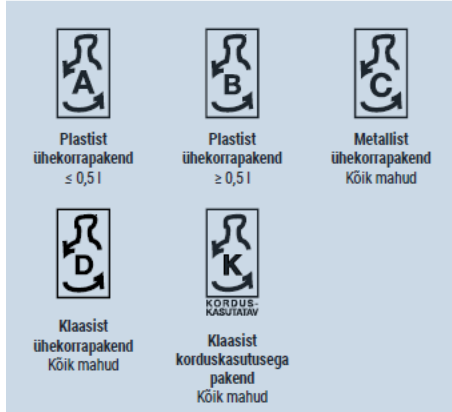

Vabatahtlikud mitte-standardised

Vabatahtlikud standardised

PABER/PAPP



PAP
Lainepapp



PAP
Papp, kartong



PAP
Paber, ajalehed, raamatud, ajakirjad, pakkepaber, paberkotid

METALL



FE
Teras



ALU
Alumiinium

KLAAS



GL
Läbipaistev klaas



GL
Roheline klaas



GL
Pruun klaas

PLAST



PET
Nt joogi-pudelid, toidukarbid, toidutopsid, kile



HDPE
Nt pudelid, purgid, kanistrid, korgid, kastid



PVC
Nt kosmeetika kanistrid ja pudelid, sildid, jäigad kiled



LDPE
Nt kilekotid, pakendikile, pehme-pakendid



PP
Nt toidukarbid, topsid, pudelid, kile, teip



PS
Nt toidukarbid, ühekordsed nõud, kastid



OTHER
Muu plastmaterjal, erinevad kasutusala



Gary Dean Anderson - most well known as the designer of the recycling symbol, one of the most readily recognisable logos in the world.

In 1970, when Anderson was 23 years old, the Container Corporation of America (CCA) released a poster that was widely distributed to colleges and universities in the United States. Under the direction of Walter Paepcke, the CCA had established itself as a leader in corporate graphics and design.

The poster advertised a competition to design a graphic symbol which would be used on recycled paper products and which could recognize a commitment to environmental sensitivity on the part of any manufacture who was engaged in recycling.

The winning symbol would be given over to the public domain.

The competition was also to honor the first Earth Day, which was held that same year on April 22.

Allikas: [https://en.wikipedia.org/wiki/Gary_Anderson_\(designer\)](https://en.wikipedia.org/wiki/Gary_Anderson_(designer))

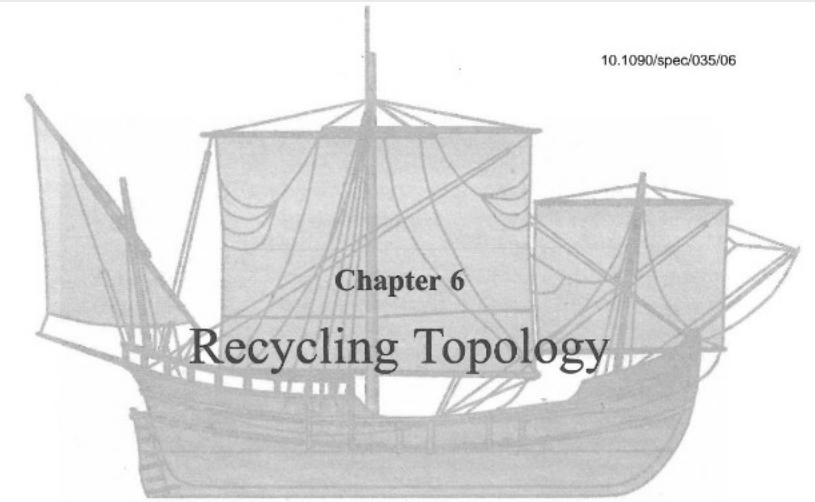
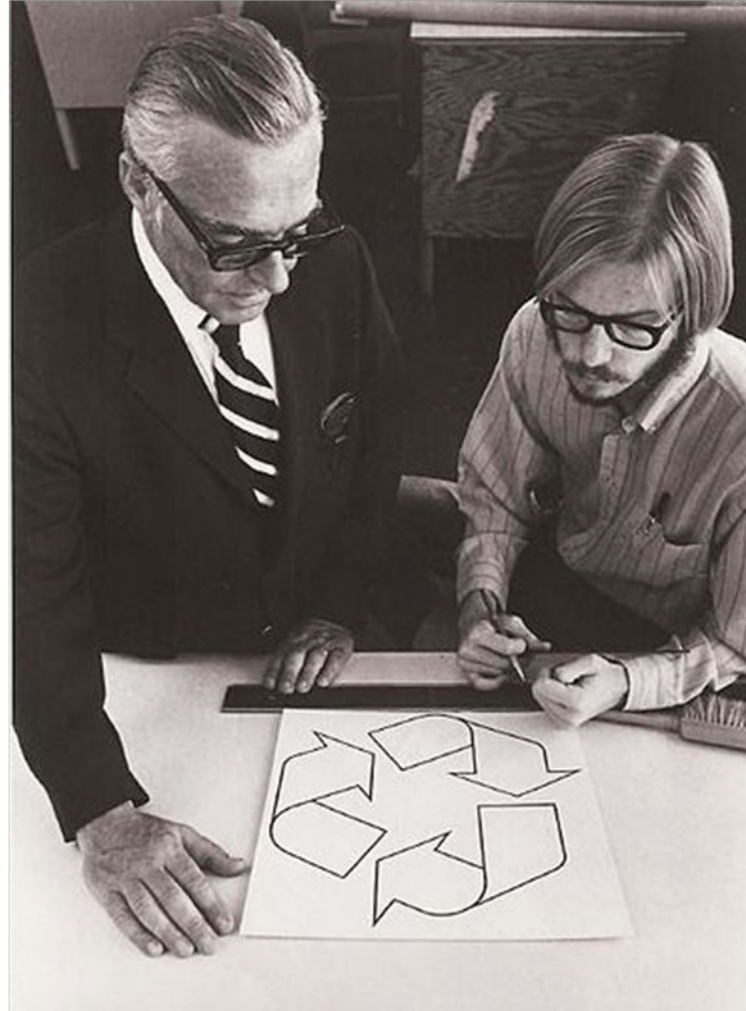

It's hard to miss the triangle of three bent arrows that signifies recycling. It appears in newspapers and magazines and on bottles, envelopes, cardboard cartons, and other containers.



The recycling symbol.

But have you noticed that there are two versions of this ubiquitous symbol? The difference between them lies in the direction of the twist in one of the three chasing arrows that make up each figure.

Cliff Long, a mathematics professor now retired from Bowling Green State University, has an eye for such details. In his mathematical studies of surfaces and shapes, he often found it inspiring to carve certain forms out of wood. "The carvings... significantly improved [my] understanding of the surfaces... and the mathematics behind them," Long says. His first sculpture, carved more than 30 years ago from a piece of white pine, was of a Möbius band.

PAKENDITE DISAINIJUHEND

Teoreetiline ja praktiline juhend
pakendiettevõtjale ja -disainerile

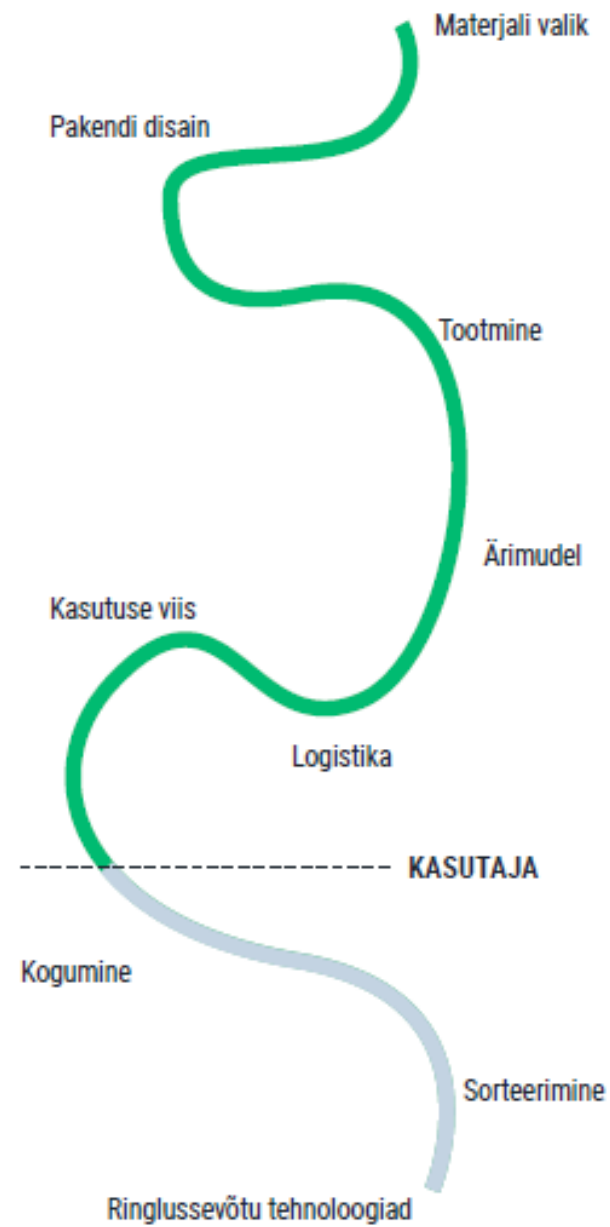



539-BS7
MD:34007

3 397 008 539 - BS7



4 047024 328372

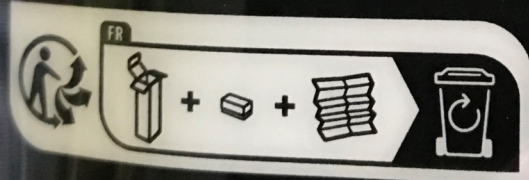

it Raccolta differenziata. Verifica le disposizioni del tuo comune.



EAC

6 000 155 015 (722) (3)

Lihakas lastevorst



100 g

Keeduvorst. **Koostisosad:** sealiha 60%, veiseliha 17%, vesi, vadakupulber (sh piim), sool, sealihavalk, kanamuna, vürtside ekstraktid, stabilisaatorid: E450, E451, E452; vürtsid, antioksüdant E300, hüdrolüüsitud taimne valk, rapsiõli, lõhna- ja maitseained, modifitseeritud tärklis, säilitusaine E250. **100 g toodet sisaldab keskmiselt:** energiasisaldus 1015 kJ / 244 kcal, rasvu 18 g, millest küllastunud rasvhapped 9,2 g, süsivesikuid 3,5 g, millest suhkrud 2,3 g, valke 17 g, soola 1,9 g. Võib sisaldada vähesel määral nisu, soja, otra, sinepit, sellerit, kala ja seesamiseemneid. Pakendatud gaasikeskkonda. "Kõlblik kuni" kuupäev kehtib kinnise pakendi korral. Avatult soovitame tarvitada 48 tunni jooksul. **Säilitada:** +2...+6 °C. **Tootja:** AS HKScan Estonia, Roodevälja küla, Rakvere vald, 44207 Lääne-Virumaa, Eesti.

rakverelk.ee

Oleme koos paremad!

Tegime selle pakendi 100% ringlusse- võetavast monomaterjalist, et saaksid sellele õigesti sorteerides anda uue elu.



PAKENDI-KONTEINER



ÄRA PÕLETAI

Kõlblik kuni:

14.10.2023



4 740003 016726

Manufacturer:
Sonett GmbH, Mistelweg 1
D-88693 Deggenhausen
Tel. +49 (0)7555.9295-0
www.sonett.eu

US: Nature Capital International LLC,
www.natcapint.com

NZ: Ceres Organics,
www.ceres.co.nz

AU: Helios Health & Beauty,
www.helioshealth.com.au

IE: Frank van Gent / Sonett Ireland,
sonettireland@gmail.com



Made in Germany





Energia	1021 kJ / 242 kcal	306 kJ / 73 kcal
Rasvad	1,6 g	0,5 g
- millest küllastunud rasvhapped	0,8 g	0,2 g
Süivesikud	42,7 g	12,8 g
- millest suhkrud	4,5 g	1,4 g
Kiudained	11,0 g	3,3 g
Valgud	8,8 g	2,6 g
Sool	1,1 g	0,4 g

Parim enne: kinnitusklambriil. Hoida kuivas ja jahedas. Värske toode sobib ka külmutamiseks ja tarbimiseks kolme kuu jooksul. Sulatatud toodet uuesti mitte külmutada.
Срок годности: на зажиме пакета. Хранить в сухом и прохладном месте. Свежий продукт подходит также для замораживания и потребления в течение трех месяцев. Размороженный продукт повторно не замораживать.

Valmistaja: AS Leibur, Leiva 1, 12618 Tallinn, Tel 650 4777, www.leibur.ee

4 740072 132518

2 viilust saad 6,6 g kiudaineid
 2 ломтика содержат 6,6 г клетчатки

Hoida loodust ja vii Leiburi taaskasutatavad pakendid ümbertöötuseks lähimasse kogumispunkti või konteinerisse. Берегите природу и сдавайте упаковки Leibur для вторичного использования в ближайший пункт сбора или контейнер для переработки.

04 PE-LD

JUURETISEGA TÄISTERALEIB

Rukkipeala

Hölpsti ringlussevõetav pakend
Valmistatud 30 % ringlussevõetavast plastist

Viegli pārstrādājams iepakojums
Satur 30 % pārstrādātas plastmasas

Lengvai perdirbama pakuotē
Pagaminta is 30 % perdirbtos plastiko

Töötame oma toodete CO₂ vähendamise nimel

Mēs strādājam pie CO₂ izmešu samazināšanas mūsu produktiem

Mēs stengiamēs **sumāzinti** savo produktu CO₂ emisijos kiekį

Looduslikud, taastuvad ja kompostitavad kiud
sāstvalt majandatavatest metsadest

Dabiskas, atjaunojamas un kompostējamas skiedras
no atbildīgi apsaimniekotiem mežiem

Natūralūs, atsinaujinantys ir kompostuojami pluoštai
iš tvariai tvarkomų miškų

Kaks lihtsat sammu: Tik vienkārsi: Du paprasti žingsniai:

Tāiuslik sobivus! Perfekta kombinācija! Tobulas derinys!

1. Kuiv 1. Sausais 1. Sausas

2. Nišks 2. Mitrāis 2. Drēgnas

RU Спецификация продукции
Туалетная бумага. Состав по волокну: первичное и вторичное волокно.
Содержит 30% переработанной пластмассы. Упаковка может быть изготовлена из переработанной пластмассы или смеси бумаги и переработанной пластмассы.

CO₂ REDUCED
PACKAGING
RECYCLABLE

Meie pakendid on taaskasutatavad ja valmistatud min. 30 % ringlussevõetud plastist - vähem plastjätmeid
Iepakojums ir izgatavots no min. 30 % pārstrādātas plastmasas un ir pārstrādājams - mazāk plastmasas atkritumu
Mūsu pakuotē yra perdirbama ir pagaminta is min. 30 % perdirbtos plastiko, kad būtu mažiau plastiko atlieky

VĀHĒNDATĀD CO₂ - HĒMĒGA JA TAASKASUTĀTĀV PĀKENDĀ / PĀRSTRĀDĀJĀMS IEPĀKOJUMS AR RĀZĪGĀNAS PROCESA SAMĀZINĀTĀM CO₂ EMISIJĀM* / PERDIRBAMA IR SUMĀZINTOS CO₂ EMISIJOS PĀKUOTĒ

* (e) Vājākem CO₂ heide saavutakse tānu pakendamisel kasutatud ringlussevõetavale materijale. Vāikemat CO₂ heidet kinnitavad olelusingi hindamise (LCA) tulemused, mida on auditeerinud välisekspert.
* (c) Zemākas CO₂ emisijas rodas no iepakojumā izmantotā pārstrādātā materiāla. Zemāku CO₂ līmeni apstiprināja dzīves cikla novērtējums (LCA), kuru ir pārbaudījusi trešā puse. Produkta plastmasas iepakojums ir paredzēts pārstrādei. Plastmasas iepakojumu pārstrāde attīstās, un šī iepakojuma pārstrāde atkarīga no pārstrādes sistēmas pieejamības jūsu valstī.
* (c) Mažesnē CO₂ emisija, kurijā lemjā pakuotēje naudojamos perdirbtos medžiagos. Apskaidētiota Gyvavimo Ciklo Vertinimo (LCA) kurj auditavo isorinė salis.

FSC MIX
Paper | Supporting responsible forestry
www.fsc.org FSC® C003255

This product is made of FSC®-certified and other controlled material.

Tooija / Gamintojas / Ražotājs / Производител:
essity Oy Essity Finland Ab
PL 1, FI-37101 Nokia, Finland
www.essity.com

1919

Eesti

Teratasku netokogus: 280 g (4

Koostisosad: rukkijahu (34%), vesi, nisujahu, idandatud rukkitera (10%), päevalilleseemned, kartulihelbed, nisukl suhkur, rukkilinnasejahu, nisugluteen, sool, pärm, paksendaja: guarkummi; antioksidant: askorbiinhape.

**TRADITSIOONILISELT KÄÄRITATUD
RUKKIJUURETISEGA. KIUDAINERIKAS.**

Valmistaja: AS Eesti Pagar, Paide, Tööstuse 34, 72720
tel: 38 49 260 e-mail: info@eestipagar.ee www.eestipagar.ee

Parim enne: vaata pakendilt



*Hoida loodust ja vii pakend
ümbertöötamiseks lähimasse
kogumispunkti või konteinerisse.*





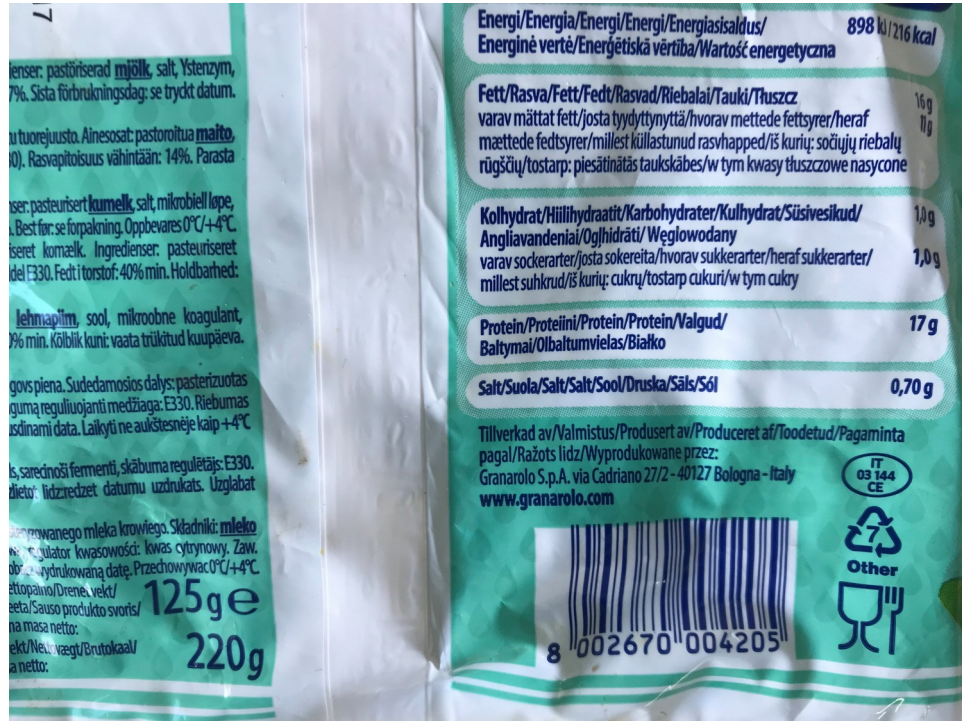

ET: ETTEVAATUST. Põhjustab rasket nahasöövitust ja silmakahjustusi. Hoida lastele kättesaamatus kohas. Vältida silma, nahale või rõivastele sattumist. Kanda kaitsekindaid/kaitseprille. NAHALE (või juustele) SATTUMISE KORRAL: võtta viivitamata kõik saastunud rõivad seljast. Loputada nahka veega/loputada duši all. SILMA SATTUMISE KORRAL: loputada nahka jooksul ettevaatlikult veega. Eemaldada kontaktläätsed, kui neid kasutatakse ja kui neid on kerge eemaldada. Loputada veel kord. Võtta viivitamata ühendust MÜRGIKUSTEABEKESKUSE või arstiga. Hoida lukustatult.

RU: ОПАСНО. При попадании на кожу и в глаза вызывает химические ожоги. Хранить в недоступном для детей месте. Избегать попадания в глаза, на кожу или одежду. Использовать перчатки/средства защиты глаз. ПРИ ПОПАДАНИИ НА КОЖУ (или волосы): Немедленно снять всю загрязненную одежду, кожу промыть водой или под душем. ПРИ ПОПАДАНИИ В ГЛАЗА: Осторожно промыть глаза водой в течение нескольких минут. Снять контактные линзы, если Вы ими пользуетесь и если это легко сделать. Продолжить промывание глаз. Немедленно обратиться за медицинской помощью. Хранить в недоступном для посторонних месте. Утилизируйте содержимое / контейнер в соответствии с местными и национальными правилами.



© A.I.S.E UFI: 7XR2-U0X2-R00A-YNSS

Tootja: / Производител:
Mayeri Industries AS.
Tartumaa, 49127
Tel. +372 77 66 700
www.mayeri.eu

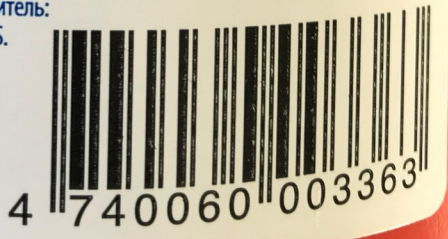

TOODELE

Mayeri

ET | Torupuhastusvahend TORUSIIL.

Effektiivne vahend kanalisatsioonitorude ummistuste kõrvaldamiseks ja ennetamiseks. Ummistuste korral valada torustikku 500ml vahendit, lasta toimida 1-2 tundi, seejärel loputada kuuma veega. Ummistuste ennetamiseks toimida samal viisil, kasutades 200 ml vahendit 1-2 korda kuus. Sobib metall- ja plasttorudele. Vahend võib erinevaid pindu söövitada. Hoida pakendit püstises asendis. Mitte kasutada looduslikest materjalidest tehtud valamutes (looduslik kivi, puit jm). Toodet säilitada AINULT originaalpakendis. Koostis: 15-30% naatriumhüdroksiid. Sisu ja pakend käidelda jäätmetena vastavalt kohalikele jäätmekäitluseeskirjadele. Tootmiskuupäeva vaata pakendilt. Säilivusaega ei piirata.

RU | Средство для отчистки канализационных труб TORUSIIL.

Средство для растворения и предотвращения засорения канализационных труб. При засорении залить 500 мл средства в канализацию и держать в течение 1-2 часов (при необходимости дольше), затем промыть горячей водой. Для профилактики засорения использовать средство 1-2 раза в месяц (200 мл). Через 1-2 часа промыть горячей водой. Средство может испортить различные поверхности. Упаковку хранить в вертикальном положении. Не использовать в раковинах, изготовленных из природных материалов (натуральный камень, дерево и т.п.). Хранить ТОЛЬКО в оригинальной упаковке. Состав: 15-30% гидроокись натрия. Утилизируйте содержимое и упаковку в соответствии с действующими местными нормами по обращению с отходами. Смотрите дату изготовления на упаковке. Срок хранения: не ограничен.

ET: ETTEVAATUST. Põhjustab rasket nahasöövitust ja silmakahjustusi.

Hoida lastele kättesaamatus kohas. Vältida silma, nahale või rõivastele sattumist. Kanda kaitsekindaid/kaitseprille. NAHALE (või juustele) SATTUMISE KORRAL: võtta viivitamata kõik saastunud rõivad seljast. Loputada nahka veega/loputada duši all. SILMA SATTUMISE KORRAL: loputada nahka jooksul ettevaatlikult veega. Eemaldada kontaktläätsed, kui neid kasutatakse ja kui neid on kerge eemaldada. Loputada veel kord. Võtta viivitamata ühendust MÜRGIKUSTEABEKESKUSE või arstiga. Hoida lukustatult.

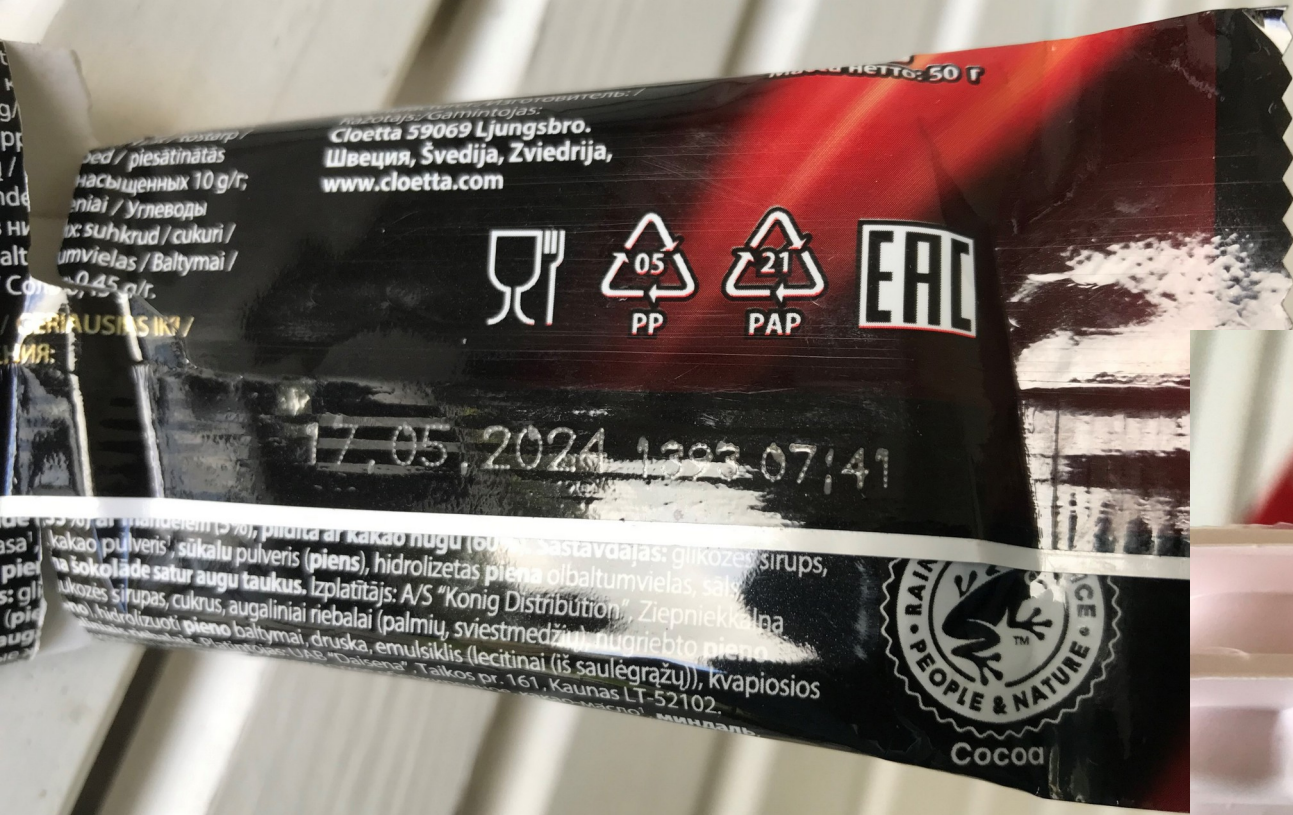

Kiitos, että huolehdit ympäristöstä!



Lajittele tyhjä pussi muovijätteeseen. Pöäsen källsorteras som plastförpackning.

Parasta ennen / Bäst före:

23.02.24 SE11 04:46:41

Paulig Finland Ltd
Satamakaari 20
FI-00980 Helsinki, Finland
www.paulig.com



Mahe-
RT MUSTIKAGA

...mustikamoos 10% (mahemustikas, mahesuhkur). Toitumisalane
... 334 kJ / 80 kcal; rasvad 3,5 g, sh küllastunud rasvhapped 2,2 g;
... 9,3 g; valgud 2,9 g; sool 0 g. Pastöriseeritud toode.

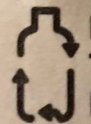

MEIE PAKEND ON TAASKASUTATAVAST PLASTIST!



To find out more about our sustainability efforts, please visit



To find ou

TRUE PLEASURE FOR THE FUTURE



To find out more about our sustainability efforts, please visit



To find out more ab

FUTURE

TRUE PLEASURE FOR THE FUTURE

TRUE PLE



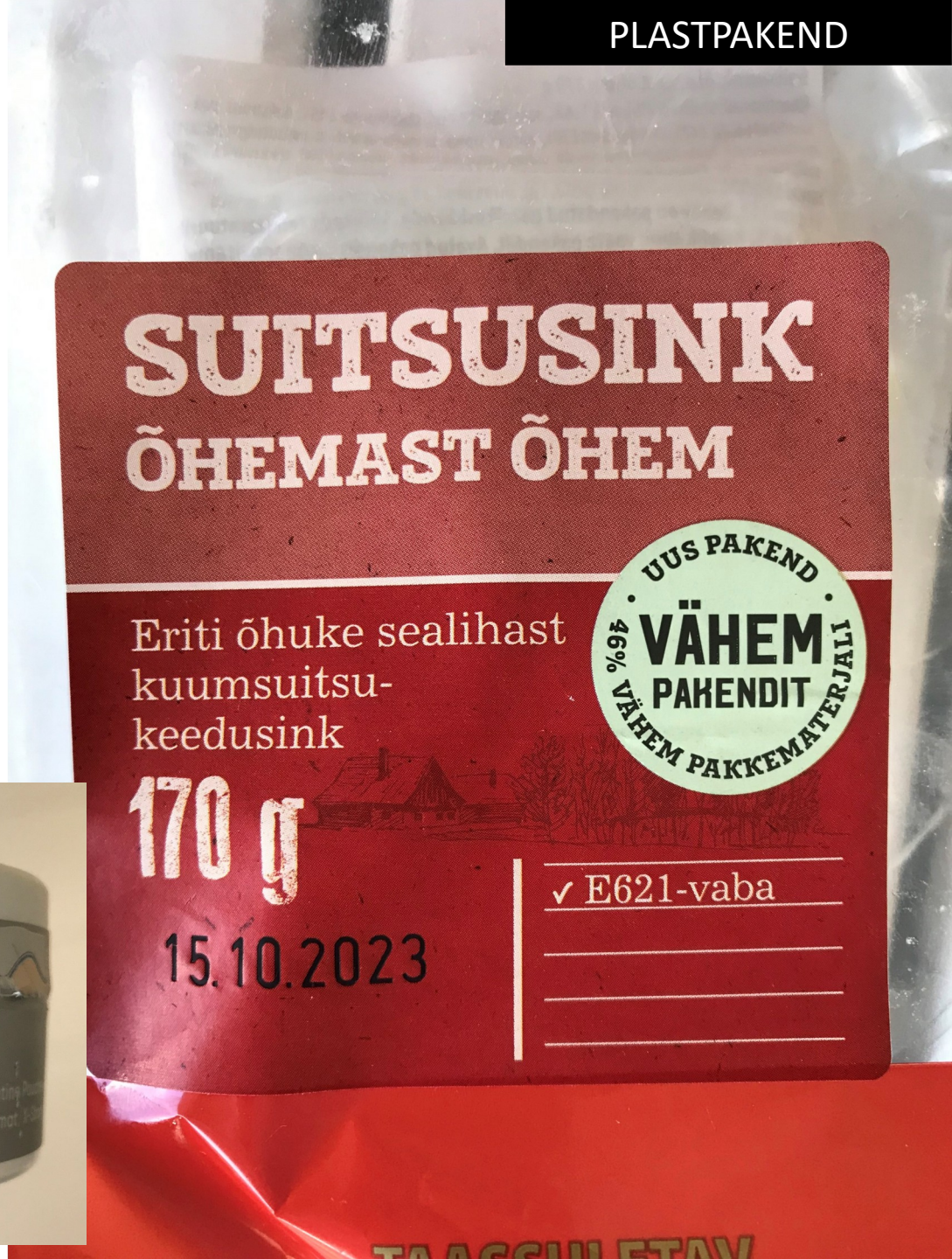

SUITSUSINK ÕHEMAST ÕHEM

Eriti õhuke sealihasst
kuumsuitsu-
keedusink

170 g

15.10.2023

UUS PAKEND
46%
**VÄHEM
PAKENDIT**
VÄHEM PAKKEMATERJALI

✓ E621-vaba

TAAGSIULETAV

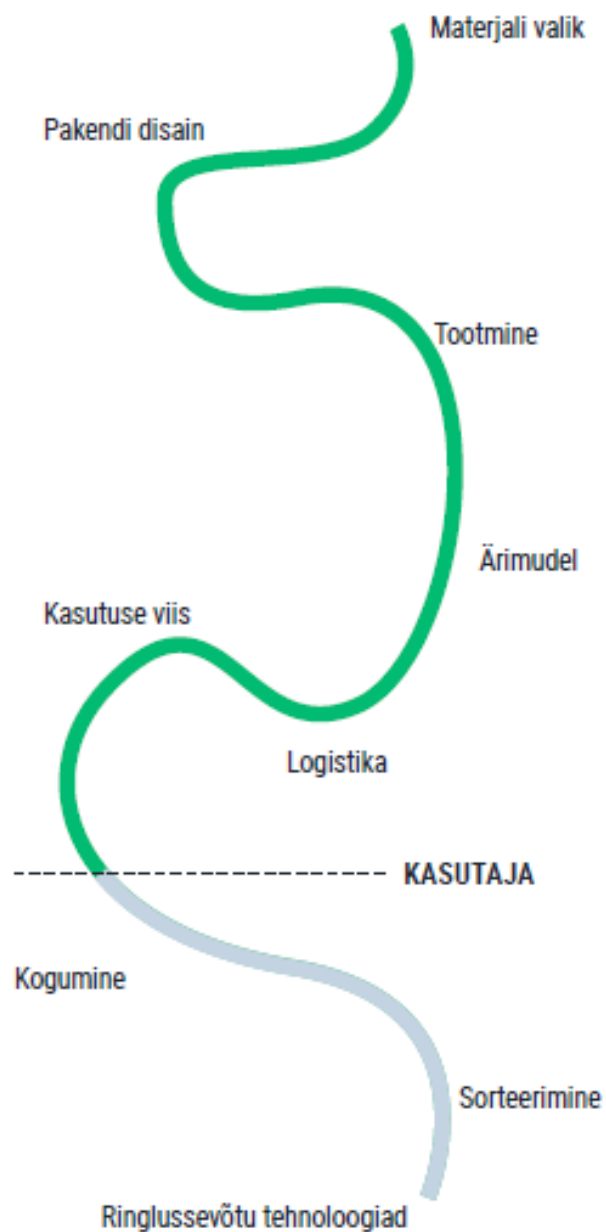

“Without fundamental redesign and innovation, about 30% of plastic packaging will never be reused or recycled”

New Plastics Economy Catalysing Action
©ELLEN MACARTHUR FOUNDATION 2017



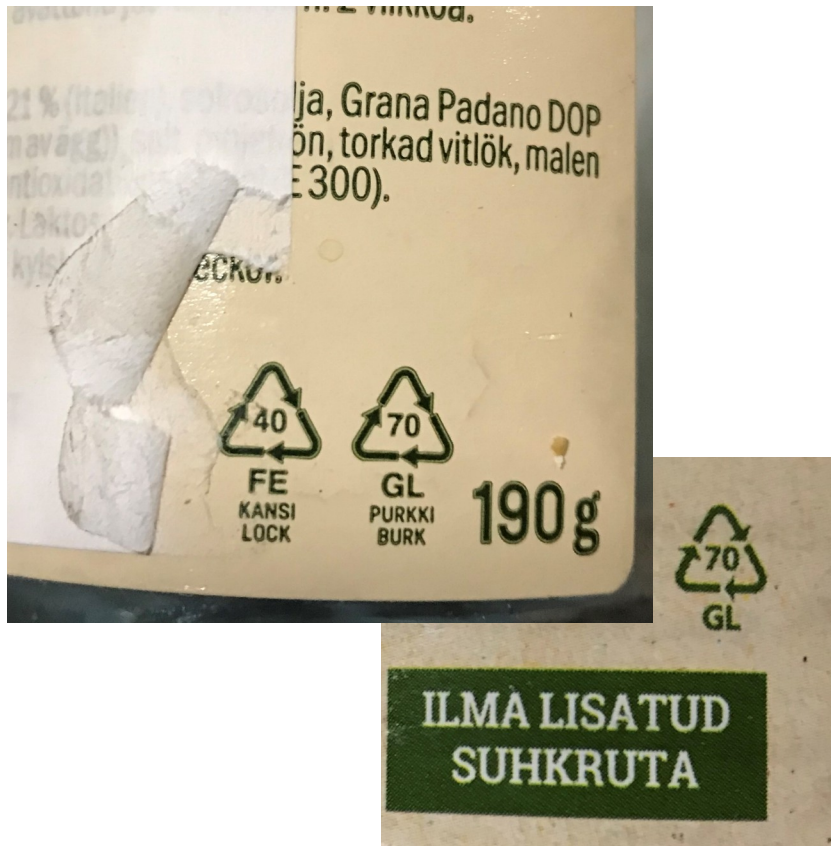









HDPE 2: raccolta plastica
C/PAP 84: raccolta carta
Verifica le disposizioni
del tuo comune.



MIX
Board | Supporting
responsible forestry
FSC® C014047



100% RECYCLABLE RECYCLABLE

ENVASE DE ORIGEN VEGETAL
PLANT ORIGIN PACKAGE
72%

EMISIONES DEL ENVASE
PA PACKAGE EMISSIONS
0g CO2e

**NUESTRO COMPROMISO CON EL PLANETA
OUR COMMITMENT WITH THE PLANET**



LA AVUTARDA
A SALVO EN NUESTRO PAÍS
250 HECTÁREAS EN NUESTRA
FINCA DE HUELVA PARA RESPETAR
SU HABITAT NATURAL

THE GREAT BUSTARD
IS SAFE IN OUR COUNTRY
250 HECTARES ALLOCATED IN OUR HUELVA ESTATE
TO THE CONSERVATION OF ITS NATURAL HABITAT

 **DONSIMON.COM**



MIXTO
Cartón | Apoyando la
silvicultura responsable
FSC® C081801

**ESTE CARTÓN CERTIFICADO CONTRIBUYE A
LA PRESERVACIÓN DE LOS BOSQUES.
THIS CERTIFIED PACKAGE CONTRIBUTES
TO THE PRESERVATION OF FORESTS.**



Valmistaja/Tillverkare/Manufacturer:
Fredman Ope





PAKENDITE DISAINIJUHEND

Teoreetiline ja praktiline juhend
pakendiettevõtjale ja -disainerile

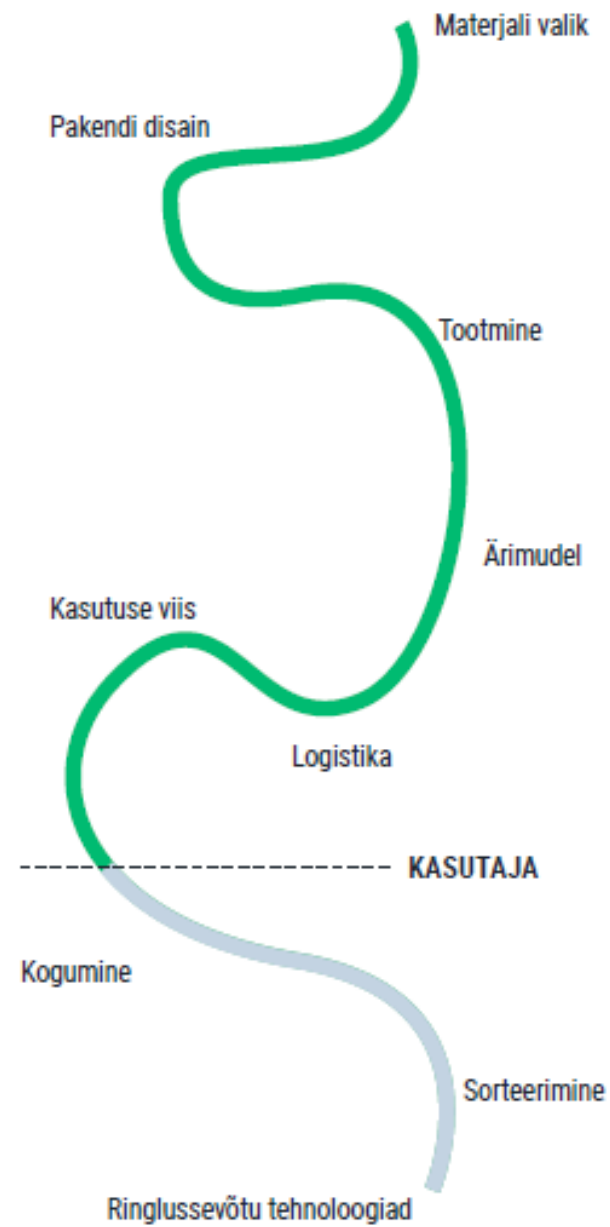

To be calm
is the highest
achievement
of the self.

GB8

Love is
an infinite
victory.

GB8